

MST-5

USER'S MANUAL

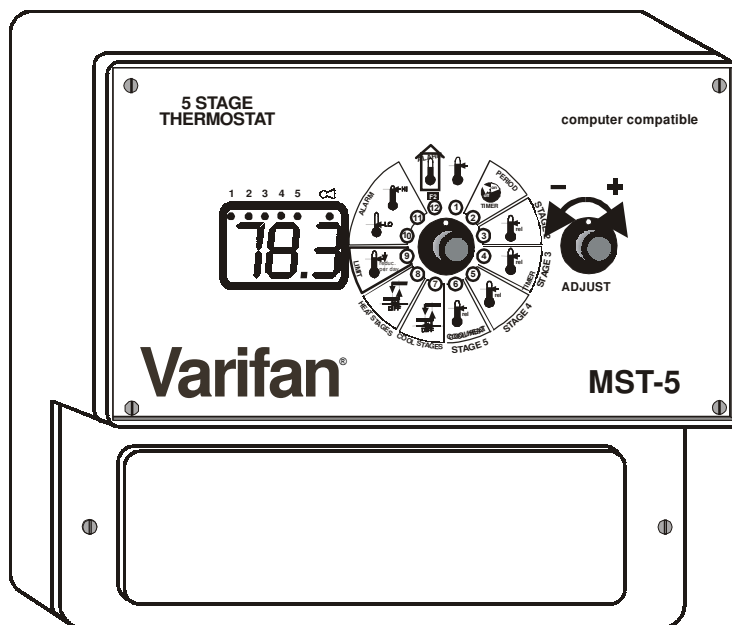

Although the manufacturer has made every effort to ensure the accuracy of the information contained herein, this document is subject to change without notice due to ongoing product development.

WARNING AND PRECAUTIONS

Equipment , probe failure, blown fuses and/or tripped breakers may prove harmful to the contents of the building. Therefore it is strongly recommended to install backup devices and alarm or warning devices. Spare equipment should also be available at the owner's site. Equipment manufactured by the manufacturer is protected against normal line surges. High surges caused by thunder storms or power supply equipment may damage this equipment. For added security against line voltage surges it is recommended that surge and noise suppression devices be installed at the electrical distribution panel. Use of shielded cable for probes is recommended for protection against lightning. These devices are available from most electrical supply distributors.

RECOMMENDATIONS

The manufacturer recommends that all installation procedures described herein be performed by a qualified electrician or installation technician. Further more the manufacturer recommends to test all the functions and equipment connected to the MST, including the alarm system and backup devices, after installation, after change to the installation and once a month after that.

Fuse verification and replacement, as well as the proper setting of control values shall be the responsibility of the owner.

TABLE OF CONTENTS

CHAPTER 1 - INTRODUCTION

1.	General	5
1.1	Description.....	5
	Definition of terms	7

CHAPTER 2 - INSTALLATION

2.1	Unpacking.....	9
2.2	Mounting	9
2.3	Switch Settings.....	10
2.3.1	Line Voltage Selector Switch.....	10
2.3.2	Software Settings Switch.....	10
2.4	Connection Procedure.....	11
2.4.1	Input Power	11
2.4.1.1	115 VAC	11
2.4.1.2	230 VAC	11
2.4.2	Wiring diagram	11
2.5	Temperature probe.....	12
2.5.1	Single Temperature Probe	12
2.5.2	Averaging	12
2.6	Alarm	12
2.7	Powering Up.....	13

CHAPTER 3 - USER GUIDE

LED Status Window.....	19
Control Dials.....	19

PRIMARY FUNCTIONS

Main Set Point Temperature.....	21
Stage 1 Duty Cycle timer.....	22
Stage 2 Relative Set Point.....	23
Stage 3 Relative Set Point.....	24
Stage 4 Relative Set Point.....	25

CONTENTS CONTINUED...

Stage 5 Relative Set Point 26
Differential Cool Stages 27
Differential Heat Stage 28
Ramping 29
Record Low Temperature 30
Record High Temperature 31
Ambient Room Display 32

SECONDARY FUNCTIONS

Stage 1 Duty Cycle Period 33
Drip Cool Duty Cycle 34
Stage 4 (Heating or Cooling mode) 35
Stage 5 (Heating or Cooling mode) 36
Minimum Ramping 37
Low Temperature Alarm 38
High Temperature Alarm 39

APPENDIX

Troubleshooting 40
Specifications 41
Record Form 42

1. GENERAL

This document provides a description of the MST-5 control panel. This document is organized as follows:

- Introduction
- Installation
- User's Guide
- Appendix

1.1 DESCRIPTION

Congratulations on the purchase of your MST-5 Multistage Thermostat. The MST product line provides you with full control over temperature by heating or cooling, resulting in a comfortable environment for your livestock.

The MST-5 provide the next features:

- Compatible with 2 speed motors
- Hi / Lo temperature recall
- Timer on first stage non active above the set point
- Timer for drip cool unit
- Automatic temperature ramping
- Adjustable differential for cooling and heating stages

The MST-5 provides microprocessor control over a five stage output.

The first stage controls a single speed fan or the first speed of a 2 speed motor. The stage also includes a programmable duty cycle and adjustable timer setting.

The second stage provides control over a second single speed fan or the second speed of a 2 speed fan.

The third stage provides control over a third fan or the first speed of a 2 speed fan. The third stage can be used for a drip cool unit with an adjustable timer setting.

The fourth stage controls a heater for cooler climates or a fourth single speed fan or the second speed of a double speed fan.

DESCRIPTION CONTINUED...

The fifth stage controls another heater for colder climates or an other single speed fan.

The MST-5 provides you with full control over all five stages via the use of an easy to follow display panel. All programmable features can be customized to meet your requirements. The MST-5 keeps you constantly informed by displaying the status of all of its outputs as well as the ambient temperature.

Safety of livestock is ensured by the continuous control of climate and timely alarm notification should environmental conditions exceed alarm set points. Further security may be obtained by connecting all MST series controls in a network configuration to a computer via the use of an optional RCM 40 remote monitoring unit. This provides remote control monitoring of each room.

The MST-5 provides an constant automatic temperature reduction (ramping) feature for your maturing livestock. A built in low temperature safety factor prevents temperatures from reaching dangerous limits.

With MST-5 controlling of your climate, you are assured of optimal living conditions for your livestock.

MAIN SET POINT

The desired room temperature. Other temperature settings on the MST-5 are relative to the main set point temperature.

RELATIVE TEMPERATURE

A value added to or subtracted from the main set point which results in a new temperature at which a desired action starts or stops.

ROOM TEMPERATURE

The actual temperature of the room.

RAMPING

An automatic daily reduction in the main set point and all temperature settings relative to this.

DIFFERENTIAL

ON/OFF (relay). Range of temperature where two conditions are possible. The output depends on whether the temperature was increasing or decreasing when it enters that range. The differential helps to avoid frequent starts and stops of the actuator when temperature is close to the relative set point.

DRIP COOL

Cooling system using evaporation to cool down livestock.

CHAPTER 2 - INSTALLATION

Chapter 2 describes the installation of the MST-5 control.

The manufacturer recommends to closely observe the following installation procedure, and that all work be performed by a certified electrician. Failure to do so may void the warranty!

2.1 UNPACKING

Unpack the MST-5 and inspect contents for damage. Should the contents appear to be damaged, contact your local distributor to return the material.

The package should contain the following standard items:

- 1 MST-5 control
- 1 installed temperature probe (model number 2004-1K)
- 1 User's manual

The following optional items may be included:

- 3 additional temperature probes for temperature averaging.

2.2 MOUNTING

To limit the unit's exposure to noxious gases install the unit in a hallway.

Make sure the unit is mounted right, side up with the cable entry holes facing down.

The MST-5 will operate in a temperature range of 32°F to 120 °F (0 °C to 50 °C).

The enclosure is watertight, but it is not splash proof or immersion proof. DO NOT WATER the control. Cover the control carefully with plastic when you are cleaning the room.

It is prohibited to use overhead cables outside the building.

MST 5

Use a screwdriver to remove the faceplate and the plate of the power compartment.

Mounting hardware is not shipped with the unit.

Install mounting screw on wall and hang the unit in place by sliding the rear mounting hole of the MST-5 over the screw.

Use two more screws to secure the MST-5 in place using the bottom mounting hole.

2.3 SWITCH SETTINGS

The MST-5 is configured for a variety of options via two switches as follows:

2.3.1 - Line Voltage Selector Switch

This switch is located on the surface of the main (bottom) board and adapts the MST-5 for 115 VAC or 230 VAC line voltage.









230V

Refer to Figures 1, and 2.

115V

2.3.2 - Software Settings Switch

This switch is located at the rear of the MST-5 faceplate and adjusts the following options.

OFF	ON	OFF	ON	
		1	Fahrenheit	Celsius
		2	Settings locked	Settings unlocked
		3	Stages 1 & 2 = Double Speed	Stages 1 & 2 = Single Speed
		4	Stages 3 & 4 = Double Speed	Stages 3 & 4 = Single Speed

Switch 1 Selects between a Fahrenheit or Celsius display on the front panel.

Switch 2 Locks/unlocks user settings. All settings except for main set point, record low, and record high temperature are locked while this switch is off.

Switch 3 Stage 1 & 2 for two singles speed fan or for one double speed fan.

Switch 4 Stage 3 & 4 for two singles speed fan or for one double speed fan.

2.4 CONNECTION PROCEDURE

For the connection procedures which follow refer to figures 1 and 2.

2.4.1 - Input power

Use a screwdriver to remove cable knock-outs for the installation of cabling to the MST-5.

Do not apply power to the MST-5 and all loads until all connections have been completed!

2.4.1.1 - 115 VAC

Make certain that the line voltage selector switch is set to 115 VAC. Connect the power cable to terminals 11 and 12 on the main (bottom) board, connect the ground wire to terminal 13 on the main board.

2.4.1.2 - 230 VAC

Make sure that the line voltage selector switch is set to 230 VAC. Connect the power cable to terminals 11 and 12 on the main (bottom) board, connect the ground wire to terminal 13 on the main board.

2.4.1.2 WIRING DIAGRAM

To use the MST-5 with single speed fans, refer to figure 1, and to use with double speed fans, refer to figure 2.

2.5 TEMPERATURE PROBES

Temperature probes use a “Class 2” low voltage circuit. These cables (caliber #18AWG min) can be extended up to a distance of 500 feet (150 meters). Single probe temperature connection is illustrated in figure 3, while 4 temperature averaging probe connection is illustrated in figure 4.

Use shielded cabling for probes . Connect the shields to the “SHLD” terminal. Failure to do so may result in inaccurate readings!

2.5.1 Single Temperature Probe

Install a single temperature probe in an area that best reflects the overall room temperature. Connect the two leads and the shield of the temperature probe to the MST terminals labeled “Probe”, as indicated in figure 3.

2.5.2 Averaging (optional)

Four temperature probes are required to do temperature averaging in larger rooms. Place the probes in appropriate locations to best average the room temperature. Refer to figure 4.

2.6 ALARM

The MST-5 provides a normally open and normally closed dry contact for alarming low or high temperature conditions. In addition, that same contact may be used to signal a power failure. This contact may be connected to an alarm system, or directly to a siren and / or an auto-dialer.

Momentary power interruptions may trigger false alarms! To avoid false alarming when the MST is connected to an alarm system, install a time delay relay between the MST and the alarm system.

2.7 POWERING UP

Before powering up the MST-5, attach the faceplate to the casing of the MST-5 using the six screws previously removed.

Set Selector knob to position (12).

Upon powering up, the unit will test it's display by briefly lighting all the segments of it's LED display. Make sure that all segments light up.

Following the LED display test, the unit displays the room temperature.

If the temperature is not displayed, refer to the Trouble Shooting section in the appendix of this manual.

Fig. 1
Wiring diagram for 3 single speed fans and 2 heating units.

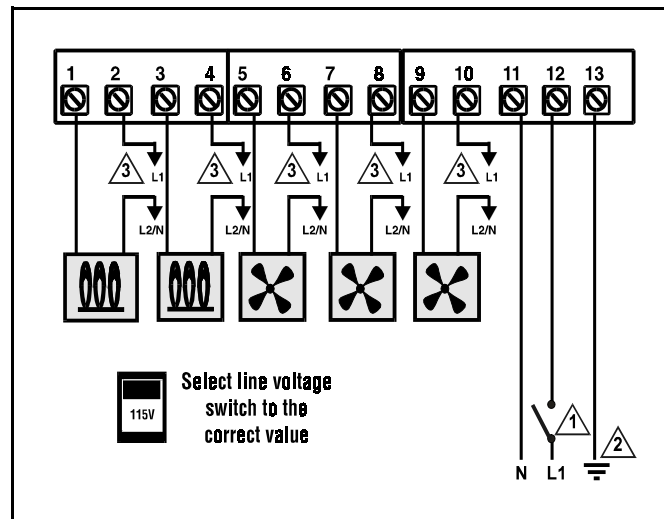
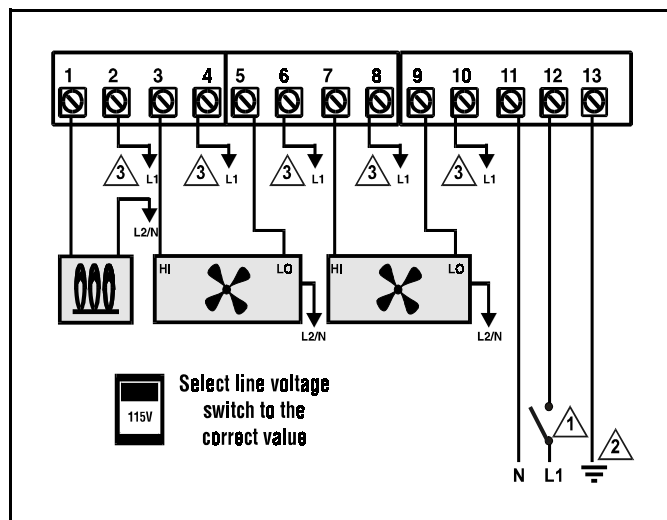

Fig. 2
Wiring diagram for 2 double speed fans and 1 heating unit.



Notes for Figures 1 and 2.

- ⚠ Power cut and protection devices in case of overload.
- ⚠ Connect the grounding wire to the ground terminal 13.
- ⚠ **IMPORTANT** Must be on a 15A separate circuit of the MST. Make sure to disconnect power of the source and all loads before wiring.

CHAPTER 2 - INSTALLATION

Fig. 3.
Probes and alarm wiring.

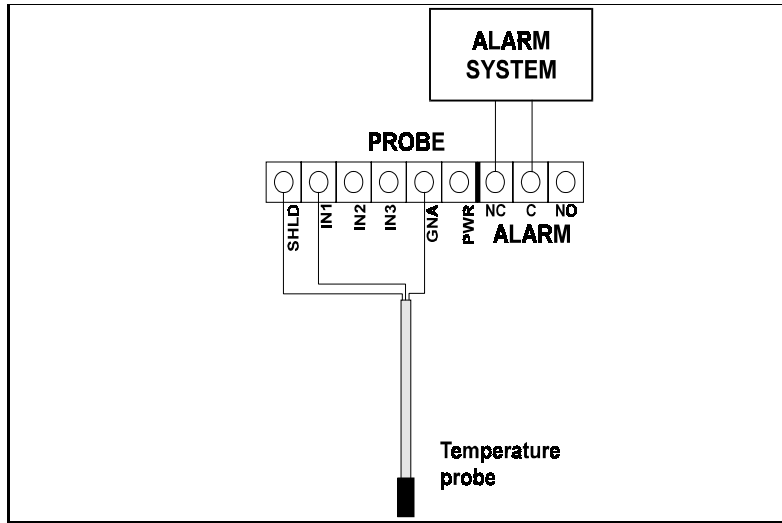

Fig. 4
Temperature average probe connection.

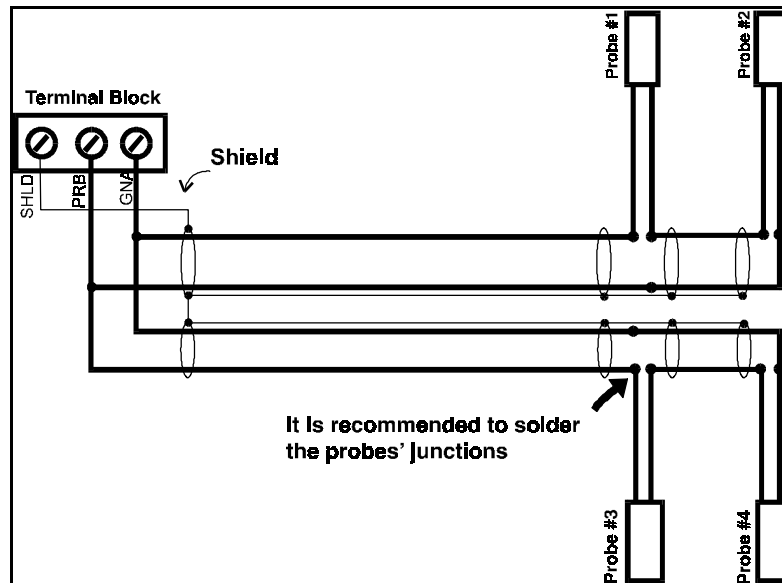
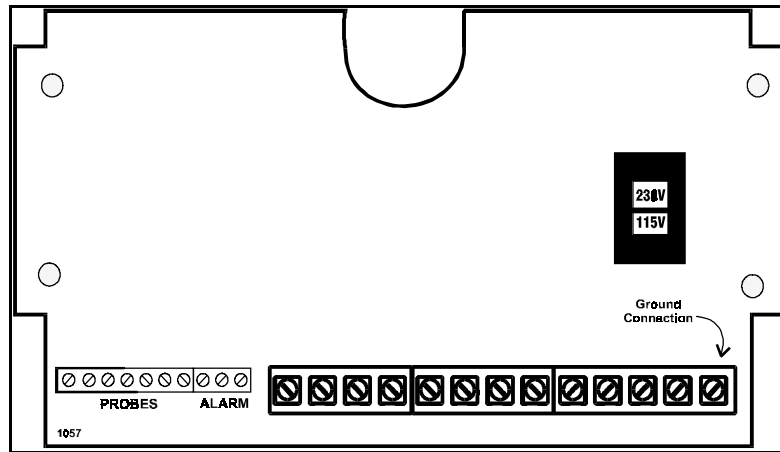
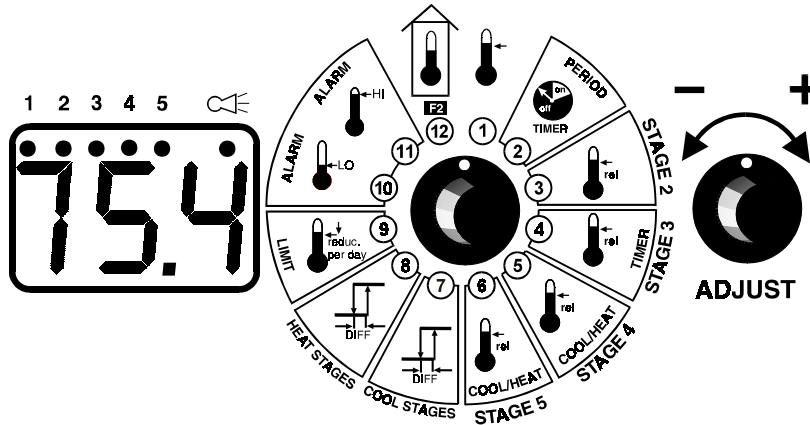

Fig. 5
Main (bottom) Board: terminal blocks and ground connection.



CHAPTER 3
USER'S GUIDE



The MST 5 front panel shown above features a LED status window and two control dials which are respectively used to select a function and adjust a setting.

LED STATUS WINDOW

The LED status window features a 3 digit LED display for temperature in Fahrenheit or Celsius, and programmable settings.

In addition, the LED status window displays the operational status of stage 1 through 5 via six additional LEDs (shown above in LED window). When illuminated, each LED indicates that its respective fan or heater is functioning. The sixth LED lights up to indicate a low or high temperature alarm condition.

CONTROL DIALS

The center dial is the selector dial and is used to select one of the control panel's 12 primary or 7 secondary functions. The dial located to the right of the selector dial is the adjuster dial and is used to enter secondary function mode and to adjust the setting of each function.

NOTE

The dip switch #2 must be ON to allow you to change all settings.

The 12 primary functions are:

- 1 Main set point temperature
- 2 Stage 1 duty cycle timer
- 3 Stage 2 relative set point
- 4 Stage 3 relative set point
- 5 Stage 4 relative set point
- 6 Stage 5 relative set point
- 7 Temperature differential for cool stages
- 8 Temperature differential for heat stages
- 9 Ramping
- 10 Record LO temperature
- 11 Record HI temperature
- 12 Room temperature display

Any one of these functions is selected by rotating the selector dial to the corresponding number and associated graphical image printed on the faceplate of the MST. When primary functions 1 through 11 are selected, the LED status window displays a blinking value. Function 12 displays room temperature.

The 7 secondary functions are:

- 2 Stage 1 duty cycle period
- 4 Drip cool duty cycle timer
- 5 Stage 1 Heat / Cool
- 6 Stage 2 Heat / Cool
- 9 Ramping minimum temperature limit
- 10 Low temperature alarm
- 11 High temperature alarm

Select any one of these secondary mode functions by:

- rotating the Selector dial to (12)
- rapidly rotating the adjuster dial back and forth to enter secondary mode.
- rotating the selector dial from function (12) to any other function.

When secondary functions 2, 4 through 6, and 9 through 11 are selected, the status window displays a blinking value along with a scrolling LED display. Selection of function 12 removes the MST from the secondary function mode.

PRIMARY FUNCTIONS

MAIN SET POINT

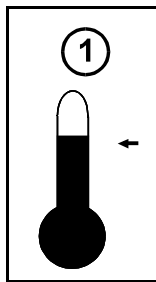

The main set point establishes the target temperature in the building. This value is used as the reference point for other settings. The main set point temperature is adjusted in 0.5 degree increments from a minimum setting of 13.5°F (-9.5°C) to a maximum setting of 105.0° F (41.0°C).

Adjusting the main set point temperature:

- rotate the Selector dial to position (1),
- rotate the Adjuster dial counterclockwise to decrease the temperature setting, and clockwise to increase it.

The main set point temperature is displayed on the MST-5.

Note: The ramping feature (primary function 9) must be (OFF) to adjust the main set point.

STAGE 1 DUTY CYCLE

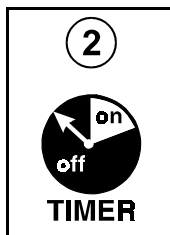

As long as the actual temperature is below the main set point, stage 1 operates under a timer. Otherwise, the timer is deactivated and the fan stays ON until the main set point (minus the differential) is reached. The stage 1 duty cycle sets the percentage of time the fan is ON versus the percentage of time the fan is OFF. The ON time is entered as a percentage of the total time which we know as the period. (The period is set to function 2 in secondary mode).

The stage 1 duty cycle is adjusted in 5% increments from a minimum setting of OFF, 5%, 10% etc., up to a maximum setting of ON corresponding to continuous operation.

Adjusting the duty cycle of Stage 1:

- rotate the selector dial to position (2),
- rotate the adjuster dial counterclockwise to decrease the duty cycle, and clockwise to increase it.

The duty cycle is displayed on the MST-5.

Example: The period of stage 1 is set to 8 minutes by secondary function (2), while the duty cycle is set to 25%. As long as the main set point temperature of the room has not been reached, the stage operates for 2 minutes, and stop for 6 minutes.

STAGE 2 RELATIVE SET POINT

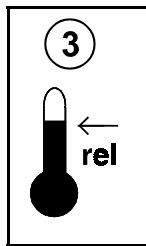

The stage 2 relative set point establishes the temperature above the main set point at which stage 2 begins to operate. The value is a temperature **difference** from the main set point.

The stage 2 relative set point is adjusted in 0.5 degree increments from a minimum setting of 0.0°F (0.0°C) to a maximum setting of 32.0°F (16.0°C).

Adjusting the relative set point of stage 2:

- rotate the selector dial to position (3),
- rotate the adjuster dial counterclockwise to decrease the relative set point, and clockwise to increase it.

The stage 2 relative set point is displayed on the MST-5.

If a 2 speed motors is used, stage 1 shuts off when stage 2 begins to operate.

Example: A main set point of 70°F along with a stage 2 relative set point of 2°F is selected. When the room temperature reaches 72°F, stage 2 begins to operate.

STAGE 3 RELATIVE SET POINT

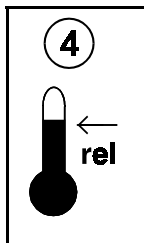

The stage 3 relative set point establishes the temperature above the main set point at which stage 3 begins to operate. The value is a temperature **difference** from the main set point.

The stage 3 relative set point is adjusted in 0.5 degree increments from a minimum setting of 0.0°F (0.0°C) to a maximum setting of 32.0°F (16.0°C).

Adjusting the relative set point of stage 3:

- rotate the selector dial to position (4),
- rotate the adjuster dial counterclockwise to decrease the relative set point, and clockwise to increase it.

The stage 3 relative set point is displayed on the MST-5.

Example: A main set point of 70°F along with a Stage 3 relative set point of 4°F is selected. When the temperature of the room reaches 74°F, Stage 3 begins to operate.

STAGE 4 RELATIVE SET POINT

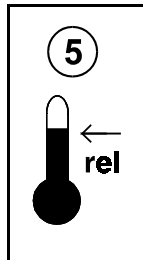

The stage 4 relative set point is the relative temperature at which Heater/Fan of stage 4 begins to operate. This value is the temperature **difference** from the main set point.

When a heater is being controlled, the relative set point is below the main set point. When a fan is being controlled, the relative set point is above the main set point.

The stage 4 relative set point temperature is adjusted in 0.5 degree increments from a minimum setting of -15.0°F (-10.0°C) to a maximum setting of 32.0°F (16.0°C).

Adjusting the stage 4 relative temperature:

- rotate the selector dial to position (5),
- rotate the adjuster dial counterclockwise to decrease the relative set point, and clockwise to increase it.

The stage 4 relative set point is displayed MST-5.

If a 2 speed motors is used, stage 3 shuts off when stage 4 begins to operate.

Example: The main set point temperature is adjusted to 70°F. A heater is in use and the relative set point is adjusted to -2°F. When room temperature reaches 68°F the heater begins to operate.

A fan is in use and the relative set point is adjusted to 6° F. When room temperature reaches 76°F, stage 4 begins to operate.

STAGE 5 RELATIVE SET POINT

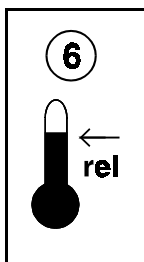

The stage 5 relative set point is the relative temperature at which Heater/Fan of stage 5 begins to operate. This value is the temperature **difference** from the main set point.

When a heater is being controlled, the relative set point is below the main set point. When a fan is being controlled, the relative set point is above the main set point.

The stage 5 relative set point temperature is adjusted in 0.5 degree increments from a minimum setting of -15.0°F (-10.0°C) to a maximum setting of 32.0°F (16.0°C).

Adjusting the Stage 5 relative temperature:

- rotate the selector dial to position (5),
- rotate the adjuster dial counterclockwise to decrease the relative set point, and clockwise to increase it.

The stage 5 relative set point is displayed MST-5.

Example: The main set point temperature is adjusted to 70°F. A heater is in use and the relative set point is adjusted to -4°F. When room temperature reaches 66°F, the heater begins to operate.

A fan is in use and the relative set point is adjusted to 8°F. When room temperature reaches 78°F, stage 5 begins to operate.

DIFFERENTIAL COOL STAGES

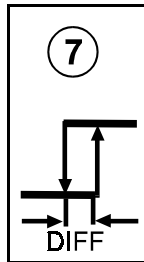

In order to minimize erratic behavior of all stage in cooling mode when room temperature is exactly at the relative set point, the differential setting separates this ON/OFF threshold into two: one ON threshold and one OFF. This feature greatly reduces equipment wear.

The temperature difference between the two thresholds is called the differential.

The differential is adjusted in 0.5 degree increments from a minimum setting of 0.5°F (0.5°C) to a maximum setting of 10°F (5°C) degrees.

Adjusting the differential for cool stage setting:

- rotate the selector dial to position (7),
- rotate the adjuster dial counterclockwise to decrease the differential setting, and clockwise to increase it.

The differential setting is displayed on the MST-5.

DIFFERENTIAL HEAT STAGES

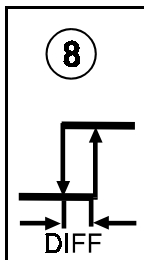

In order to minimize erratic behavior of all stages in heating mode when room temperature is exactly at the relative set point, the differential setting separates this ON/OFF threshold into two: one ON threshold and one OFF. This feature greatly reduces equipment wear.

The temperature difference between the two thresholds is called the differential.

The differential is adjusted in 0.5 degree increments from a minimum setting of 0.5°F (0.5°C) to a maximum setting of 10°F (5°C) degrees.

Adjusting the differential for heat stage setting:

- rotate the selector dial to position (8),
- rotate the adjuster dial counterclockwise to decrease the differential setting, and clockwise to increase it.

The differential setting is displayed on the MST-5.

RAMPING

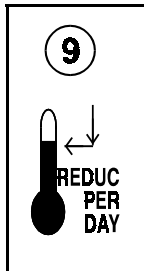

The ramping function automatically reduces the main set point by the set value every 24 hours.

The ramping setting is adjusted in 0.01 degree decrements from a minimum setting of OFF, -0.01°F (-0.01°C) to a maximum setting of -0.99°F (-0.50°C).

The main set point must be greater than the limit.

Adjusting ramping:

- rotate the selector dial to position (9),
- rotate the adjuster dial counterclockwise to increase the ramping rate, and clockwise to decrease it.

The ramping setting is displayed on the MST-5.

NOTE: When ramping is activated, the main set point temperature cannot be manually adjusted.

Ramping automatically shuts OFF when the minimum temperature limit is reached!

Example: The main set point temperature is set to 70°F and ramping is adjusted to -0.05°F. The following day the main set point temperature drops to 69.95°F followed by 69.90°F on the next day. Although the main set point real value decreases, the display will be changed after 10 days. The main set point will then be 69.5°F.

RECORD LOW TEMPERATURE

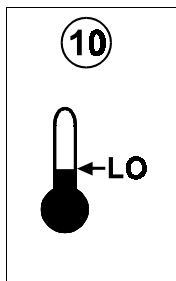

This function displays the lowest recorded temperature since the last clear.

The record low temperature is rounded to the nearest 0.5 degree from a minimum display of 13.5°F (-10.0°C) to a maximum display of 105.0°F (41.0°C). If a temperature lower than 13.5°F is recorded, **Lo** is displayed.

Viewing the lowest temperature recorded:

- rotate the selector dial to position (10)

Clearing the low temperature value

- quickly rotate the adjuster dial counterclockwise, then clockwise.

CLr will be briefly displayed on the MST-5.

RECORD HIGH TEMPERATURE

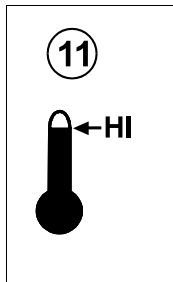

This function displays the highest recorded temperature since the last clear.

The record high temperature is rounded to the nearest 0.5 degree from a minimum display of 13.5°F (-10.0°C) to a maximum display of 105.0°F (41.0°C). If a temperature higher than 105.0°F is recorded, **Hi** is displayed.

Displaying the highest temperature recorded:

- rotate the selector dial to position (11)

Clearing the high temperature value

- quickly rotate the adjuster dial counterclockwise, then clockwise.

CLr will be briefly displayed on the MST-5.

ROOM TEMPERATURE DISPLAY

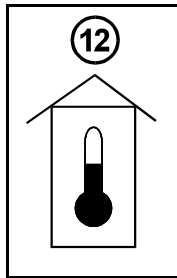

This function displays the room temperature. The selector dial should normally be left at this position.

Room temperature is displayed to the nearest 0.1 degree from a minimum display of 13.5°F (-10.0°C) to a maximum display of 105.0°F (41.0°C). If the temperature is lower than 13.5°F, **Lo** is displayed. If the temperature is higher than 105.0°F, **Hi** is displayed.

Viewing the room temperature:

- rotate the selector dial to position (12)

Room temperature is displayed on the MST-5.

STAGE 1 DUTY CYCLE PERIOD

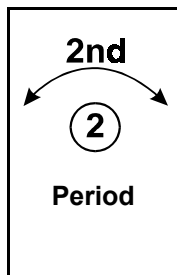

The stage 1 duty cycle period is adjusted in conjunction with the stage 1 duty cycle timer (primary function 2). The stage 1 duty cycle period is the total time in ON-OFF fan cycle.

The period is adjusted by 1 minute increments from a setting of 1 minute to a maximum setting of 10 minutes.

Adjusting the stage 1 duty cycle period:

- rotate the selector dial to position (12),
- rapidly rotate the adjuster dial back and forth to enter secondary function mode,
- rotate the selector dial to position (2),
- rotate the adjuster dial counterclockwise to decrease the period, and clockwise to increase it.

The stage 1 period setting is displayed on the MST-5.

DRIP COOL DUTY CYCLE

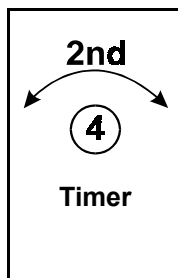

As long as the actual temperature is below the main set point, the drip cool unit will not operate. When room temperature rises above the stage 3 relative set point, configured by primary function (4), the drip cool units begins to operate in a duty cycle mode. The duty cycle sets the percentage of time the drip cool unit is ON versus the percentage of time the unit is OFF. The ON time is entered as a percentage of a **12 minutes** period. If a fan is used, set this value at 100%.

Adjusting the duty cycle setting:

- rotate the selector dial to position (12),
- rapidly rotate the adjuster dial back and forth to enter secondary function mode,
- rotate the selector dial to position (4),
- rotate the adjuster dial counterclockwise to decrease the duty cycle setting, and clockwise to increase it.

The duty cycle setting is displayed on the MST-5.

Example: The duty cycle is set to 25%. When room temperature rises above the relative set point the drip cool units operates for 3 minutes, and go OFF for 9 minutes.

STAGE 4 HEATING OR COOLING MODE

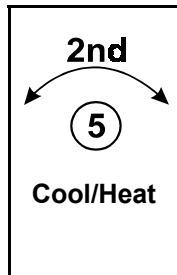

Select if the stage 4 operates in heating mode or cooling mode.

The stage 4 (heating or cooling mode) is adjusted by selecting HEA or COO. HEA on the display if you want to use the stage 4 in heating mode or COO on the display if you want to use the stage 4 in cooling mode.

Adjusting the stage 4 heating or cooling mode:

- rotate the selector dial to position (12),
- rapidly rotate the adjuster dial back and forth to enter secondary function mode,
- rotate the selector dial to position (5),
- rotate the adjuster dial counterclockwise to set the stage in heating mode, and clockwise to set it in cooling mode.

The heating or cooling mode is displayed on the MST-5.

If stage 4 is set for a 2 speed motor, it is not possible to adjust this stage in heating mode.

STAGE 5 HEATING OR COOLING MODE

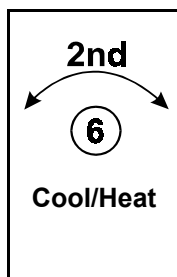

Select if the stage 5 operates in heating mode or cooling mode.

The stage 5 (heating or cooling mode) is adjusted by selecting HEA or COO. HEA on the display if you want to use the stage 5 in heating mode or COO on the display if you want to use the stage 5 in cooling mode.

Adjusting the stage 5 heating or cooling mode:

- rotate the selector dial to position (12),
- rapidly rotate the adjuster dial back and forth to enter secondary function mode,
- rotate the selector dial to position (6),
- rotate the adjuster dial counterclockwise to set the stage in heating mode, and clockwise to set it in cooling mode.

The heating or cooling mode is displayed on the MST-5.

MINIMUM RAMPING

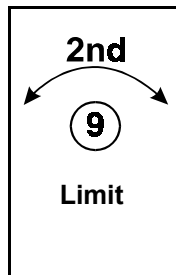

Minimum ramping is the lowest that the ramping function can adjust the main set point to. This is a security feature.

The minimum ramping setting is adjusted in 0.5 degree increments from a minimum setting of 13.5°F (-9.5°C) to a maximum setting of 105.0°F (41.0°C).

Adjusting the minimum ramping setting:

- rotate the Selector dial to position (12),
- rapidly rotate the Adjuster dial back and forth to enter secondary function mode,
- rotate the Selector dial to position (9),
- rotate the Adjuster dial counterclockwise to decrease the minimum ramping setting, clockwise to increase it.

The minimum ramping setting is displayed on the MST-5.

NOTE: When the main set point temperature reaches the minimum ramping limit, the ramping setting (primary function 9) automatically shuts off.

LOW TEMPERATURE ALARM

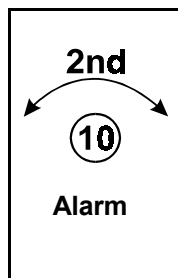

This function establishes the temperature **difference** below the main set point that the room can reach before a low temperature alarm is signaled. When a low temperature alarm occurs an alarm contact is activated and the alarm LED lights on the MST.

The low temperature alarm is adjusted in 0.5 degree increments from a minimum setting of -32.0°F (-18.0°C) to a maximum setting of 0.0°F (0.0°C).

Adjusting the low temperature alarm setting:

- rotate the selector dial to position (12),
- rapidly rotate the adjuster dial back and forth to enter secondary function mode,
- rotate the selector dial to position (10),
- rotate the adjuster dial counterclockwise to decrease the setting, and clockwise to increase it.

The low temperature alarm setting is displayed on the MST-5.

HIGH TEMPERATURE ALARM

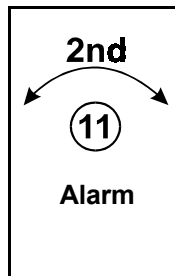

This function establishes the temperature **difference** above the main set point that the room can reach before a high temperature alarm is signaled. When a high temperature alarm occurs, an alarm contact is activated and the alarm LED lights up on the MST.

The high temperature alarm is adjusted in 0.5 degree increments from a minimum setting of 0°F (0°C) to a maximum setting of 32.0°F (18.0°C)

Adjusting the high temperature alarm:

- rotate the selector dial to position (12),
- rapidly rotate the adjuster dial back and forth to enter secondary function mode,
- rotate the selector dial to position (11),
- rotate the adjuster dial counterclockwise to decrease the setting, and clockwise to increase it.

The high temperature alarm setting is displayed on the MST-5.

TROUBLESHOOTING

SYMPTOM	CAUSE and REMEDY
Lo is continually displayed	<ul style="list-style-type: none">- Temperature is below minimum (13.5°F or -10.0°C).- Probe is disconnected or defective.
Hi is continually displayed	<ul style="list-style-type: none">- Temperature is above maximum (105.0°F or 41°C).- Probe is short circuited.
Fan(s) or heater not operating	<ul style="list-style-type: none">- Verify whether the fan LED is on. If LED is on yet fan or heater is not operating, verify wiring, and fan or heater.
Stage 4 and 5. Fan or Heater is operating erratically	<ul style="list-style-type: none">- Verify that the function on position 5 and 6 in secondary mode is correctly adjusted.- Verify the minimum rating (10mA at 115V or 20mA at 230V).
Display is blank	<ul style="list-style-type: none">- Verify that the line voltage selector switch is properly set.- Verify that the 10 pin flat cable between the main board and the faceplate board is connected.

Storage

Temperature: -4 to 130°F (-20 to 55°C)

Operation

temperature: 32 to 122°F (0 to 50°C)

Weight:

5 pounds (2.25Kg)

Dimension:

8.35"x4.60"x7.87" (212x117x200mm)

SPECIFICATIONS

DESCRIPTION	VALUE
INPUT POWER	<ul style="list-style-type: none"> - 12 W - 115/230 -20%, +10% VAC - 50 / 60 Hz
STAGE 1 (dry relay contact) Not Fused	<ul style="list-style-type: none"> - 10 AMP ; 115V/230V - 1/2 HP @ 115V - 1 HP @ 230V - Min. Rating 10mA at 115V* - 20mA at 230V*
STAGE 2 (dry relay contact) Not Fused	<ul style="list-style-type: none"> - 10 AMP ; 115V/230V - 1/2 HP @ 115V - 1 HP @ 230V - Min. Rating 10mA at 115V* - 20mA at 230V*
STAGE 3 (dry relay contact) Not Fused	<ul style="list-style-type: none"> - 10 AMP ; 115V/230V - 1/2 HP @ 115V - 1 HP @ 230V - Min. Rating 10mA at 115V* - 20mA at 230V*
STAGE 4 (dry relay contact) Not Fused	<ul style="list-style-type: none"> - 10 AMP ; 115V/230V - 1/2 HP @ 115V - 1 HP @ 230V - Min. Rating 10mA at 115V* - 20mA at 230V*
STAGE 5 (dry relay contact) Not Fused	<ul style="list-style-type: none"> - 10 AMP ; 115V/230V - 1/2 HP @ 115V - 1 HP @ 230V - Min. Rating 10mA at 115V* - 20mA at 230V*
ALARM (dry relay contact)	<ul style="list-style-type: none"> - 2 AMP; 30V AC/DC

* Relay will not function properly if load is smaller than the min. value.

RECORD FORM

Dial	Option	Default setting		User setting
1	Main Set Point Temperature	77°F	25°C	
2	Stage 1 Duty Cycle Timer	ON	ON	
3	Stage 2 Relative Set Point	4°F	2°C	
4	Stage 3 Relative Set Point	6°F	3°C	
5	Stage 4 Relative Set Point	8°F	4°C	
6	Stage 5 Relative Set Point	10°F	5°C	
7	Temperature Differential Heat Stage	2°F	1°C	
8	Temperature Differential Cool Stage	2°F	1°C	
9	Ramping	OFF	OFF	

2nd Function

2	Stage 1 Cycle Period	2 min	2 min	
4	Stage 3 Duty Cycle Timer	ON	ON	
5	Stage 4 Heating or Cooling mode	HEAT	HEAT	
6	Stage 5 Heating or Cooling mode	HEAT	HEAT	
9	Minimum Ramping Limit	65°F	18°C	
10	Lo Temperature Alarm	-8°F	-5°C	
11	High Temperature Alarm	20°F	12°C	

Limited Warranty

The manufactured equipment and supplied components have gone through rigorous inspection to assure optimal quality of product and reliability. Individual controls are factory tested under load, however the possibility of equipment failure and/or malfunction may still exist.

For service, contact your local retailer or supplier. The warranty period shall be for two years from manufacturing date. Proof of purchase is required for warranty validation.

In all cases, the warranty shall apply only to defects in workmanship and specifically exclude any damage caused by over-voltage, short circuit, misuse, acts of vandalism, fortuitous events, acts of God, flood, fire, hail, lightning or any other natural disaster. Any unauthorized work, modification or repair on this product automatically voids the warranty and disclaims the manufacturer from all responsibility.

The manufacturer assumes only those obligations set forth herein, excluding all other warranties or obligations. This warranty stipulates that in all cases the manufacturer shall be liable only for the supply of replacement parts or goods and shall not be liable for any personal injury, damages, loss of profits, interrupted operations, fine contravention of the law or damages to the production of the PURCHASER and the PURCHASER shall take up the defense and hold the manufacturer faultless regarding any legal or extra legal proceedings, notice, or claim by the customer or by a third party, and regarding any legal and extra legal expenses and fees brought forward on by such damages.

MAV MST-5M Ver: 1.1
October 1995
Rev. July 1997
Rev. June 2001